

NOTICE

Note that when converting this document from its original format to a .pdf file, some minor font and format changes may occur. When viewing and printing this document, we cannot guarantee that your specific PC or printer will support all of the fonts or graphics. Therefore, when you view the document, fonts may be substituted and your individual printer may not have the capability to print the document correctly.

NEC

Electra **Elite** IPK II

**Wireless DECT
Handset User's Guide**

(Revision 1)

Handset - User's *Guide*



Congratulations on your new DECT handset

The handset will provide you with the greatest possible degree of flexibility and mobility due to high battery capacity, practical weight, size and design.

Contents:

1. Construction	4	8.5 Menu subscription and login	21
2. Battery installation	5	8.5.1 Create subscription	22
3. Charging	6	8.5.2 Login.....	23
4. Key functions	7	8.5.3 Auto login	24
5. Turning the handset ON/OFF	9	8.5.4 Remove subscription.....	25
6. Making a call.....	10	8.6 Battery	26
6.1 Receiving calls.....	12	8.7 Redial	27
6.2 During conversation	13	8.8 Book	29
6.2.1 Volume regulation	13	8.9 External services.....	31
6.2.2 Microphone mute	13	8.10 MSF Functions	32
6.2.3 Transferring the call to another handset.....	13	8.11 Mail/Text messages.....	33
7. Set ups	14	9. Shortcuts	35
8. Menu structure	15	10. Information	36
8.1 Using the alphanumeric keyboard	16	10.1 Error tree	36
8.2 Key functions.....	17	10.2 Error information	37
8.3 Profile set up	18	10.3 Warranty.....	37
8.4 Profile functions.....	20	10.4 Technical information	38

1. Construction

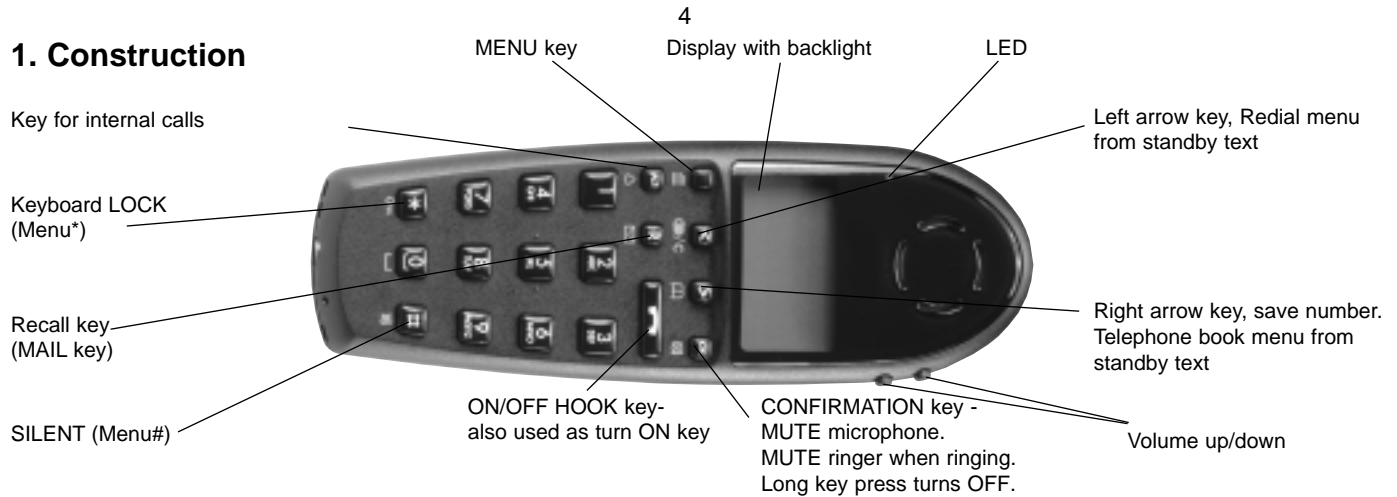

2. Battery installation

Before using the telephone it is important that you connect the battery to the connector in the battery box. Assemble the battery cover as described below and place the handset into the charger.

1. Push the battery cover 5 mm towards the headset plug using your thumbs.

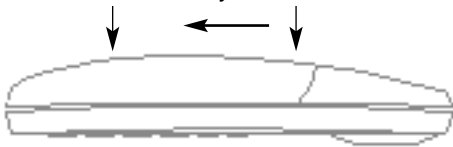

2. Lift off battery cover.
3. If the battery is not already installed, place battery plug in the slot in the battery box.
4. Insert battery with the label readable and replace cover.



Place the battery plug in the slot with red wire closest to the mark * (see figure)

3. Charging

It takes approximately 3 1/2 hours to charge the handset from fully discharged to its full capacity. Place the handset in the charger. The display shows the charging status in line 3. For correct charging the room temperature has to be between 0°C and 25°C and therefore the handset must not be placed in direct sunshine. The battery has a built-in heat sensor which will stop the charging if the battery temperature is too high.

It is necessary to recharge the battery when the display shows "BATTERY LOW", or if it can not be turned on. The LED flashes at a low frequency while charging and lights constantly when the charging has finished. The display goes back to normal mode when fully charged.

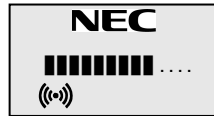





When the handset is placed in the charger the vibrator will not work and the B-answer function is inactive even if chosen. If the battery is fully discharged, it will be a moment before charging starts.

4. Key Functions

The handset has 21 keys:

Two keys are placed at the right side for volume control. Press upper or lower key to change the volume. Each key-press turns volume one step up/down.

- ☰ - Go to menu structure or exit menu structure. (Escape or »NO«)
- " < ", ○/●/C - Menu: left, Cursor left, after a digit: delete last digit. Long press: delete all.
From standby text: Redial menu.
- " > ", ☐ - Menu: right, Cursor right, After a digit: Store number in telephone book.
From standby text: Telephone book read.
- "OK", ☒ - Confirmation (»YES«) or jump to next level in the menu. In off hook: Mute.
Long key press turns the handset OFF.

- “ALT”,  -If residential systems: Internal calls off hook, and internal recall if already off hook.
- “R”,  - If off hook: Recall. If on hook: Read message.
- “” - On hook/off hook and turn ON.
- “*”,  - * Long = pause (-), extra long: change from pulse to DTMF (a “T” appears in the display, GAP standard).
- “0-9” - Digits or letters in alphanumeric mode (names and messages)
- “#” - #, Choose uppercase or lowercase letters in alphanumeric mode.

5. Turning the handset ON/OFF

ON: Press -key for 1/2 second.

When the handset is turned on the  symbol is shown in the lower left corner of the display, if the handset is subscribed to a system. (For subscription, see 8.5.1)

OFF: Press the “OK” (MUTE) key for 3 seconds.

Please note: When the handset has been outside the coverage area, it can take up to 30 seconds before the handset is back on the system after re-entering the coverage area.

6. Making a call

For making or receiving calls the handset has to be subscribed to a system (☎) shown in display) (see chap. 8.5.1)

Press the -key, the -icon in the display will flash until connection is established

Dial the number

Pre-dial:

Press the number to dial (long press on »*« will make a pause, if necessary)

Press the -key, the -icon will flash until the connection is established

Telephone book:

Press the >-key  to enter the telephone book

Search for the number either by using the <-key or the >-key or by pressing the first letter in the name by using the digits 1 – 9 (see chap. 8.2)

Press the -key, the -icon will flash until connection is established

Redial:

Redial / CLIP (CLIP = Calling Line Identification Presentation) stack:

Press the <-key /C to enter the redial/CLIP stack

Search for the number by using the <-key or the >-key, redialled numbers are marked with REDIAL or name and clip numbers are marked either with CLIP or the name of the person who called and the LED is on.

Press the -key, the -icon will flash until the connection is established.

Using the handset on residential systems:

Internal call post-dial:

Press the ALT-key () , the -icon in the display will flash

Dial the number of another handset on the base station, the -icon will flash until the connection is established

Internal call pre-dial:

Press the number of another handset on the base station

Press the ALT-key () , the -icon will flash until the connection is established

6.1. Receiving calls

If the phone rings, the call can be answered by pressing the -key.

When ringing the LED flashes fast, and the display shows the CLIP (if presented). If it is an external call (or if no CLIP) the display shows "INCOMING CALL"

It is possible to stop the ringing signal without answering the call. Press  (OK) and the ringing signal is muted. Display shows: »RINGER MUTED«

6.2 During conversation

6.2.1 Volume regulation:

Use the two keys placed at the right side of the handset for volume control.

6.2.2 Microphone mute:

Press the OK-key () , MIC. MUTED is showed in the display.

Press the OK-key () to enable the microphone again.

6.2.3 Transferring the call to another handset:

Press R, and dial new number.

Press the -key and the call is transferred to the other handset

7. Set ups

The handset has two user-defined profiles (set ups), and a mode where all sounds are disabled (SILENT). Pressing “☰” followed by “OK” will show the chosen profile. A new profile can be selected by using the arrow keys. To select the chosen profile press “OK”. To escape (without storing anything) press “☰” again.

A quick way of choosing a profile, is to press “☰” and then 1, 2 or # (1 is the INDOOR, 2 is the OUTDOOR profile and # is SILENT). To change the set up in a profile, press “☰” followed by “OK” twice. All settings have to be defined under each of the two profiles. The display shows if the SILENT mode or PROFILE2 is chosen.

8. Menu structure

Pressing the ☰-key, enters or exits the menu structure. It has to be used if a “NO” or “CLEAR” is wanted in the menu structure.

Pressing the OK-key, jumps to a lower level in the menu. When the lowest menu level is reached, it will store the setting and jump to a higher level. It has to be used if a “YES” is wanted.

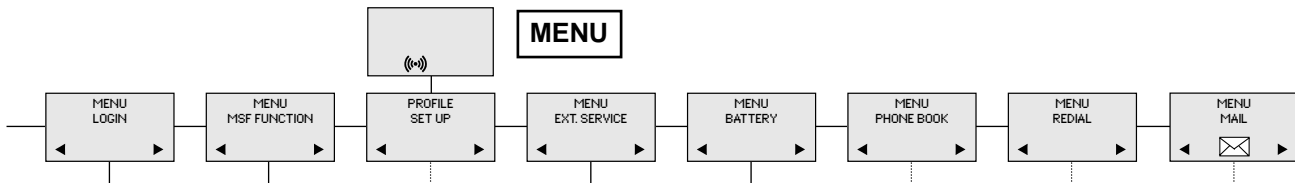

The phone book and redial menu can be accessed directly. The phone book by pressing the >-key (☐☐) and the redial menu by pressing the <-key (●/C).

8.1 Using the alphanumeric keyboard

The normal dialling keys (0-9) are used for writing the name to be placed in the phone book. By pressing the keys a certain number of times the related letters or digits will appear in the display. Spaces are made by using the 0-key. Key # changes between uppercase and lowercase letters. The arrows will move the cursor. Left arrow is also used for deleting (hold for 1 sec.) = delete. New letters can be inserted.

Change of key press and pauses lasting more than 1 second automatically moves the cursor to next position.

8.2 The key functions

Key	
1	Æ Ø Å @ Ä Ö ß Ü 1
2	A B C @ Å Ä Å Ä 2
3	D E F 3
4	G H I I I 4
5	J K L 5
6	M N O Ö Ó Ò 6
7	P Q R S ß 7
8	T U V Ü Ú Û Ü 8
9	W X Y Z 9
0	Space . , _ - + : ? ! 0
*	* # / \ () = &
#	Upper/lower-case

8.3 Profile set-up

In the following you will find a description of how to set up one of the 2 profiles. To enter the Profile Set-up menu press “☰”. Then press “OK” and use > or < to find the profile you wish to change and confirm with “OK”. You are now able to switch between the different settings. Press “OK” when you find the setting you wish to change (or see). Change the setting according to your needs, confirm with “OK” and automatically you go to the next setting. Press “☰” to finalize profile setup.

Profile set-up (fig)

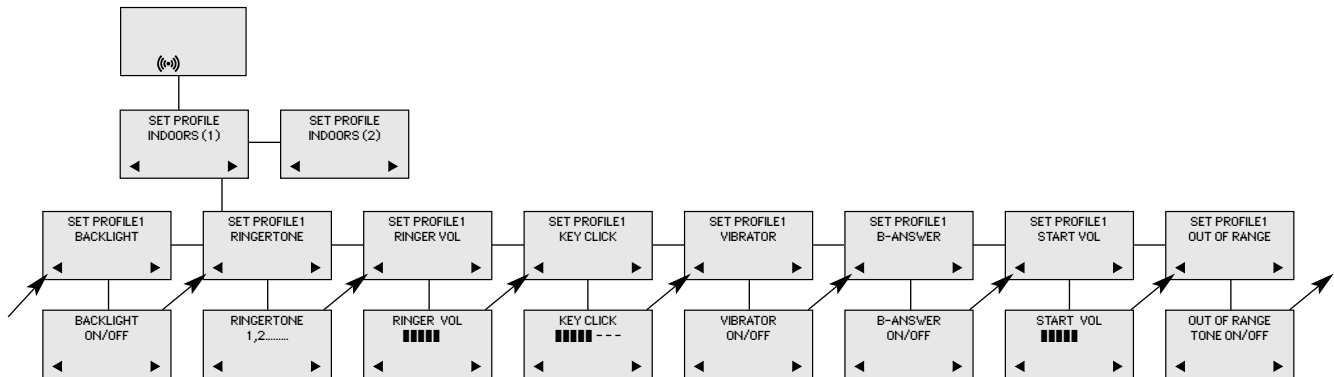

8.4 Profile functions

BACKLIGHT: Can be turned on/off using the > and <. Confirm with (OK).

RINGERTONE: Scroll through the 9 different ringtones using > and <. Confirm with (OK).

RINGER VOL: Turn the volume up and down using > or <. Confirm with (OK).

KEY CLICK: Turn the volume up and down using the > and <. Confirm with (OK).

VIBRATOR: Can be turned on/off using the > and <. Confirm with (OK).

B-ANSWER: Can be turned on/off using the > and <. Confirm with (OK). When turned on, the telephone automatically goes off hook when ringing. If subscribed to a KIRK system it automatically goes on hook when calls are terminated.

START VOL: Start volume can be adjusted using the > and <. Confirm with (OK).

OUT OF RANGE: The out of range tone can be turned on/off using the > and <. Confirm with (OK). With the Out of Range tone turned on, a beep will appear when the telephone is moved out of range of the base station

8.5 Menu subscription and login

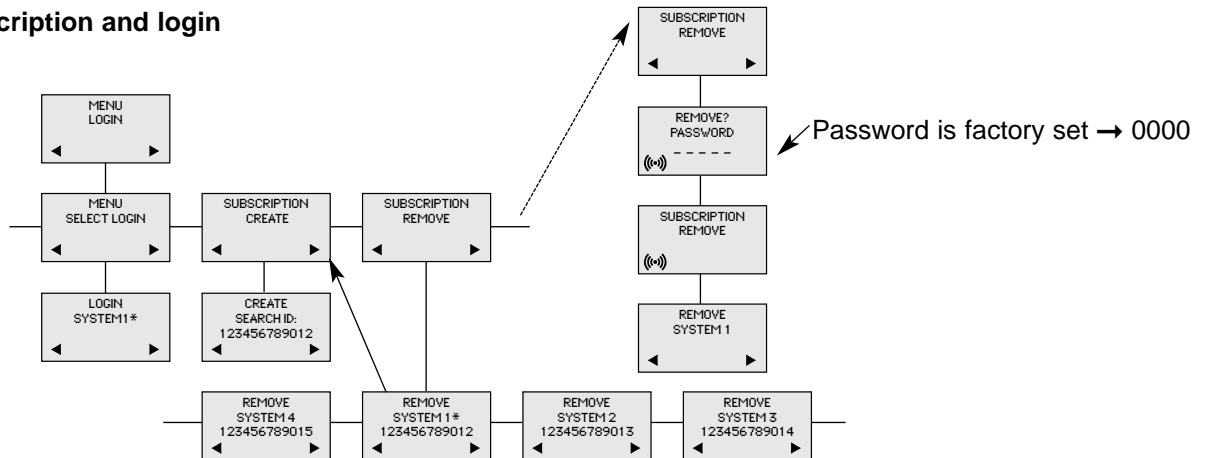

8.5.1 Create subscription

To make subscriptions, the system must allow subscriptions to be made. Some systems also require an Access Code (AC). If more than one system currently permits subscription, you will need to know the ID of the system to which you wish to subscribe. Access Codes and system ID's will be provided by the system administrator.

If the handset is already subscribed to 4 systems, you will have to remove a subscription before creating a new (see 8.5.3).

Choose the SUBSCRIPTION CREATE menu to subscribe to a new system. (see 8.5)

Use the < and > keys to scroll between the ID's of the different systems available.

Choose the system you wish to subscribe to. When a subscription is available, enter the free system using < or > and the AC (if required) using the keyboard, and press (OK).

If subscription was successful, the standby text and  is shown in the display. If not, subscription has failed and the procedure must be retried.

8.5.2 Login

The handset can be subscribed to 4 different systems enabling you to use the same handset on 4 different systems.

If you would like to change to another system, use the login menu to connect to another system number.

The actual chosen system is shown with the red LED on.

To change to another system use < or > and press OK to confirm.

To be able to log on to a system, subscription to the system has to be established. (See 8.5.1).

8.5.3 Auto login

The handset can be subscribed to 4 different systems. If Auto login is chosen from the menu, the handset automatically selects the “closest system”. The selected system is marked with an “A”.

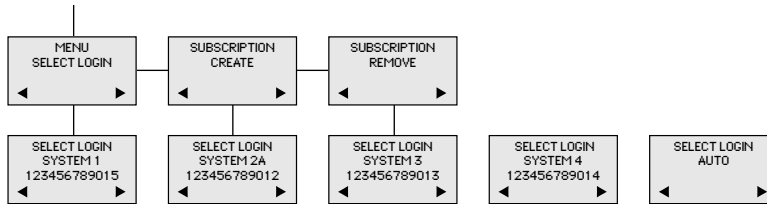

Please note: Auto login should only be used in separate systems without overlaps.

8.5.4 Remove subscription

Subscriptions can be removed from the system in use and from the 3 other systems (if connected). Removing a subscription requires a password. Password is factory set at 0000. If the system in use is removed, it is necessary either to select one of the remaining systems or to subscribe to a new one. If one of the systems not chosen is removed, the handset remains connected to the system in use.

8.6 Battery capacity

In the battery menu it is possible to see the remaining battery capacity. For reading the correct capacity, the handset has to be removed from the charger for at least one hour. Press “≡” and use the > or < keys to reach the Battery Menu. Press “OK” to enter the menu, and you can see the current status of the battery capacity. Press “OK” to return to the menu system or press “≡” to quit.

The indication on the display is not necessarily an exact reflection on the remaining speech time.

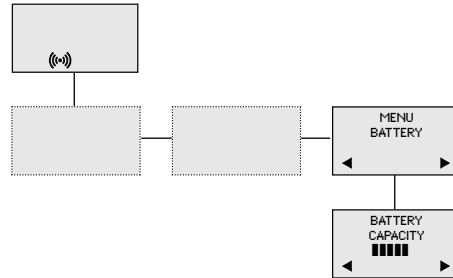

8.7 Redial

The handset has maximum 10 redial numbers and 10 Caller ID's placed in the same stack. Each number is only represented once. Enter the redial menu by pressing "<" (C/C) from the standby text. Repeated presses at the "<" button turn backward through the dialled numbers and CLIP numbers (from newest to the oldest). Right arrow moves in the opposite direction. It is also possible to reach the redial menu in the main menu. Numbers are named "REDIAL", "CLIP" or with the name.

The LED will flash slowly if a new number (unanswered call) has arrived in the CLIP stack. If no number (no clip) is represented by a call only the LED will flash slowly afterwards.

If you want to delete a "CLIP" or a "REDIAL" you scroll to the name/number and press »OK« twice.

The name/number is now deleted. If a number is stored, it is moved to the telephone book.

The Redial and CLIP stack Menu (fig)

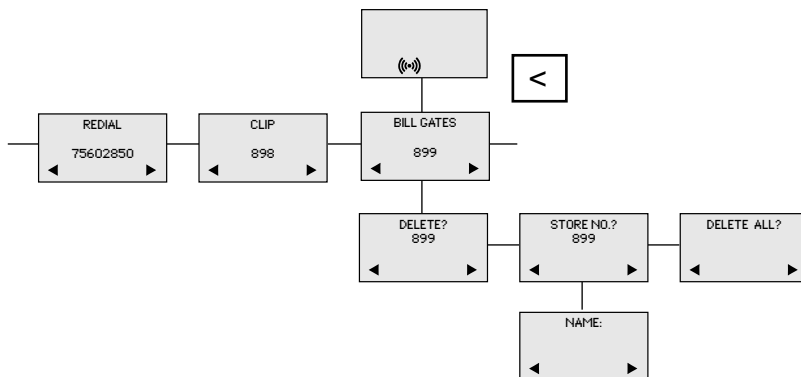

8.8 Book

Storing a number (max. 24 digits) in the telephone book is done by pressing the number to be stored (in on hook), then press the “>”- key followed by the “OK” key. It is possible to store up to 80 numbers with name in the phone book. Typing of the name and a confirmation is required. After storing the telephone will go back to standby mode. If the display shows “MEMORY FULL”, it is necessary to delete one or more numbers from the telephone book.

(See menu structure page 30)

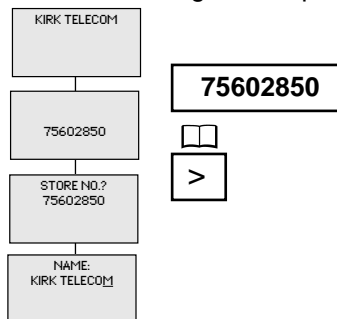

Read BOOK numbers: The telephone book is entered by pressing ">" (☰). For quick-search: press the first letter of the name (using 1-9)(see chap. 8.2). Call the displayed person by pressing the ☎ key. It is also possible to reach the telephone book menu in the main menu.

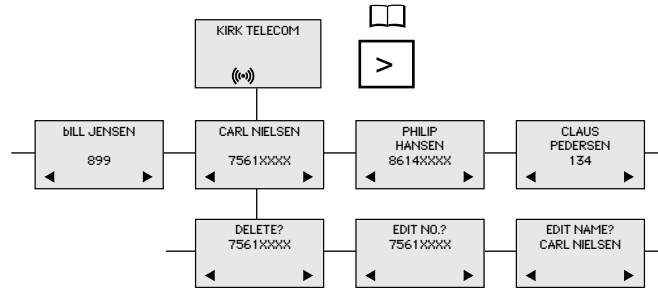

8.9 External services

External services are facilities placed in the main system, and only available if the handset is subscribed to a KIRK system

8.10 MSF-functions

MSF Functions are special functions, which are based on MSF (Message Service Function). The functions require special software in the main system.

Mail/Text Messages

Available in systems configured with the possibility of sending text messages

At the reception of a text message the envelope icon  appears in the display. The envelope icon is indicating one or more unread messages.

The text message is shown in the display, and when the message is read the envelope icon will disappear.

If the message contains a callback number, this will be displayed on the bottom line of the display. As long as the callback number is in the display, it is possible to activate the number by pressing the -key.

1st letter in the display, in front of the timestamp, shows the message status: read (R), unread (N) or locked (L). Mails include a maximum of 72 letters or digits (2 display screens of 36 each). Call back no. is max 24 digits (or letters for E-mail).

14 messages can be "stored" in the handset. When receiving a new message, the oldest unlocked will be deleted. Locked messages will not automatically be overwritten, but can manually be deleted. Maximum 7 messages can be locked.

Read a mail

Press the "R"- (MAIL) key followed by the ✓-key or enter the mail menu (in on hook condition).

If the message includes more than 36 letters or digits, the message will run over 2 display screens.

Use the > -key to scroll.

To see the **sender** of the mail, press the ✓-key.

To leave the mail, press the MENU-key.

Reply a mail

Open the mail by pressing the R-key followed by the ✓-key, press the ✓-key again and use the < >-keys to find the reply feature, press the ✓-key and you are then able to reply the mail. After writing your reply press the ✓-key to confirm.

Forward a mail

Open the mail by pressing the R-key followed by the ✓-key, press the ✓-key again and use the < >-keys to find the forward feature, press the ✓-key twice and you are then able to write the number on the receiver. Confirm with the ✓-key.

Delete a mail

Open the mail by pressing the R-key followed by the ✓-key, press the ✓-key again and use the < >-keys to find the delete feature, press the ✓-key and the mail is deleted.

Lock/unlock a mail

Open the mail by pressing the R-key followed by the ✓-key, press the ✓-key again and use the < >-keys to find the lock/unlock feature, press the ✓-key and the mail is locked/unlocked.

Write a mail

To write a new mail press the R (mail)-key, confirm with the ✓-key and write your message. To send the mail press the ✓-key, type the number of the receiver and confirm with the ✓-key.

If one or more mails are stored do as followed: Press the R (mail)-key followed by the >-key confirm with the ✓-key and write your message. Press the ✓-key, type the number of the receiver and confirm with the ✓-key. The message is send.

Note

In case a sent message is not received, the sender will get a message in the display.

Menu structure

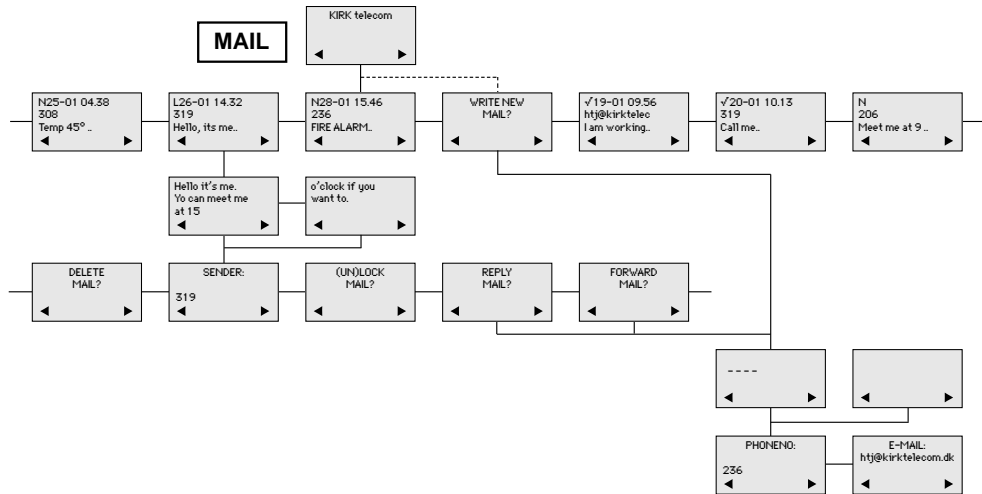

9. Shortcuts

"INDOORS PROFILE": Press: **≡** 1.

"OUTDOORS PROFILE": Press: **≡** 2. (Display shows PROFILE 2)

"SILENT": Press: **≡** #. (No sounds) (Display shows SILENT)

"KEY LOCKED": Press: **≡** *. (Display shows KEY LOCKED)

"PHONE BOOK": Press > (□□) key in standby.

Name search in phone book: Press the first letter in name and > (□□) afterwards.

Store a number: Press > (□□) after the number (in on hook).

"REDIAL" and "CLIP": Press < (●/C) key in standby.

"MAIL": Press R (✉) key in on hook.

MUTE temporarily the ringer: Press "OK" (⊗) when the telephone is ringing.

MUTE the microphone: Press "OK" (⊗) when the telephone is off hook.

RECALL: Press the ALT key if residential system, else press the "R"-key.

Pause(-): Hold * for one second.

Change from pulse to DTMF(T): Hold * for 2 seconds.

10. Information

10.1 Error tree

Problem	Check
The telephone freezes.	Remove and replace the battery pack. Press  to turn on the telephone.
The telephone does not ring.	Check whether the ringer is SILENT or RINGER VOL. is OFF.
The telephone cannot find a system ID at "SUBSCRIPTION CREATE".	Check whether the system is set to allow subscriptions.
The telephone cannot subscribe even if system ID has been found.	Check if Access Code is necessary.
Not possible to turn on the telephone	Check if battery is connected. If yes, charge the battery.

10.2 Error information

Improper function of the handset might be related to the installation of the DECT system or failures related to the main system. Before declaring a handset for repair be sure that the main system is operating properly.

10.3 Warranty

The handset is covered by a normal warranty-solution, except the battery. The lifetime of the battery depends on the general use of the handset.

The handset is not covered by a general warranty if:

- The handset is exposed to water or metal dust
- The handset is mistreated
- The handset is exposed to unauthorised break-in

10.4. Technical information

Approvals

Acoustics:	TBR 10
Electrical:	TBR 6 (DECT RF)
Access profile:	TBR 22 (GAP)
EMC:	ETS 300 329 (CE labelling)

Size and weight

Size:	143 x 48 x 26 mm
Weight:	121 g including battery \pm 10 g

Capacity

Active talking time	10 hours
Stand-by time	90 hours